

DC-DC CONVERTER

Unit 59-81, 1st Floor, New Modella Industrial Estate, Wagle Estate, Thane-400604, Maharashtra, INDIA.
 MOB:+91-8097707496/ +91-7208560460
 Email:info@powertronindia.com
 Web: www.powertronindia.com

PIPL-4805DD

240W CONVERTER

❖ FEATURES :

- Wide input supply range.
- Built in EMI filter, low ripple noise.
- Protection: Short circuit / Over load / Over voltage.
- 100% Full Load Burn in test.
- High efficiency, long life and high reliability.
- Miniature size.



❖ SPECIFICATION:

MODEL NO		PIPL-4805DD
OUTPUT	DC VOLTAGE	48VDC
	RATED CURRENT	5A
	RATED POWER	240W
	RIPPLE & NOISE (max)	<1%Of Rated Voltage
	VOLTAGE ADJ.RANGE	FIX
	VOLTAGE TOLERANCE	Rated Voltage Of +/-1%
	LINE REGULATION	<+/-0.5%
INPUT	LOAD REGULATION	<+/-0.5%
	VOLTAGE RANGE	110VDC
PROTECTION	EFFICIENCY	>85%
	OVERLOAD	Above 105% Rated Output Power Protection Type: Constant Current Recovers automatically after fault condition is removed.
	OVER VOLTAGE	125%-150% Rated Output Voltage Protection type: Hicup Mode Recovers automatically after fault condition removed.
INDICATION	LED INDICATION	INPUT OK ,OUTPUT OK
ENVIRONMENT	WORKING TEMP.	(-5DegC To 85DegC.)
	WORKING HUMIDITY	20 To 90% RH Non Condensing.
	STORAGE TEMP./ HUMIDITY	(-10 To 85DegC 10 To 95%RH)
	VIBRATION	(-10 To 500 Hz,2G,20min/Sweep,Period-1Hr,Each along X,Y,Z axes.)
SAFETY & EMC	SAFETY STANDARD	Designed To Meet UL60950-1
	WITH STAND VOLTAGE	I/P-O/P:2KVDC,I/P-Earth:2KVDC
	ISOLATION RESISTANCE	I/P-O/P, I/P-Earth, O/P-Earth: 100MOhms / 500VDC.
	EMI & EMC	Designed To Meet EN55022, EN61000-4-2.
OTHERS	ENCLOSURE PROTECTION	IP-21
	COOLING	FORCED COOLING
	DIMENSION (L*W*H)mm	200*130*90
	APPROX WEIGHT	1.42Kg
NOTE	1. All parameters NOT specially mentioned are measured at typical input, rated load and 25 Deg.c ambient Temperature. 2. Ripple & noise are measured at 20MHz of bandwidth by using a12"twisted pair-wired terminated with a0.1uf & 47uF parallel capacitor. 3. Tolerance includes set up tolerance, line regulation and load regulation. 4. The power supply is considered a component which will be installed into final equipment .The final equipment must be recon formed that it still meets EMC directives. 5. Specifications are subject to change without prior notice due to constant improvement in design & technology.	

SMPS IDC DC Converters | Adapters | Electro Plating Rectifier | POE SMPS | Battery chargers | DC AC Converter
 DC Regulator Power supply | LED Driver | Inverter | CVT | Servo controlled Voltage Stabilizer | Transformer

DATASHEET

DC-DC CONVERTER

PIPL-4805DD



Unit 59-81, 1st Floor, New Modella
Industrial Estate, Wagle Estate,
Thane-400604, Maharashtra, INDIA.
MOB:+91-8097707496/ +91-7208560460
Email:info@powertronindia.com
Web: www.powertronindia.com

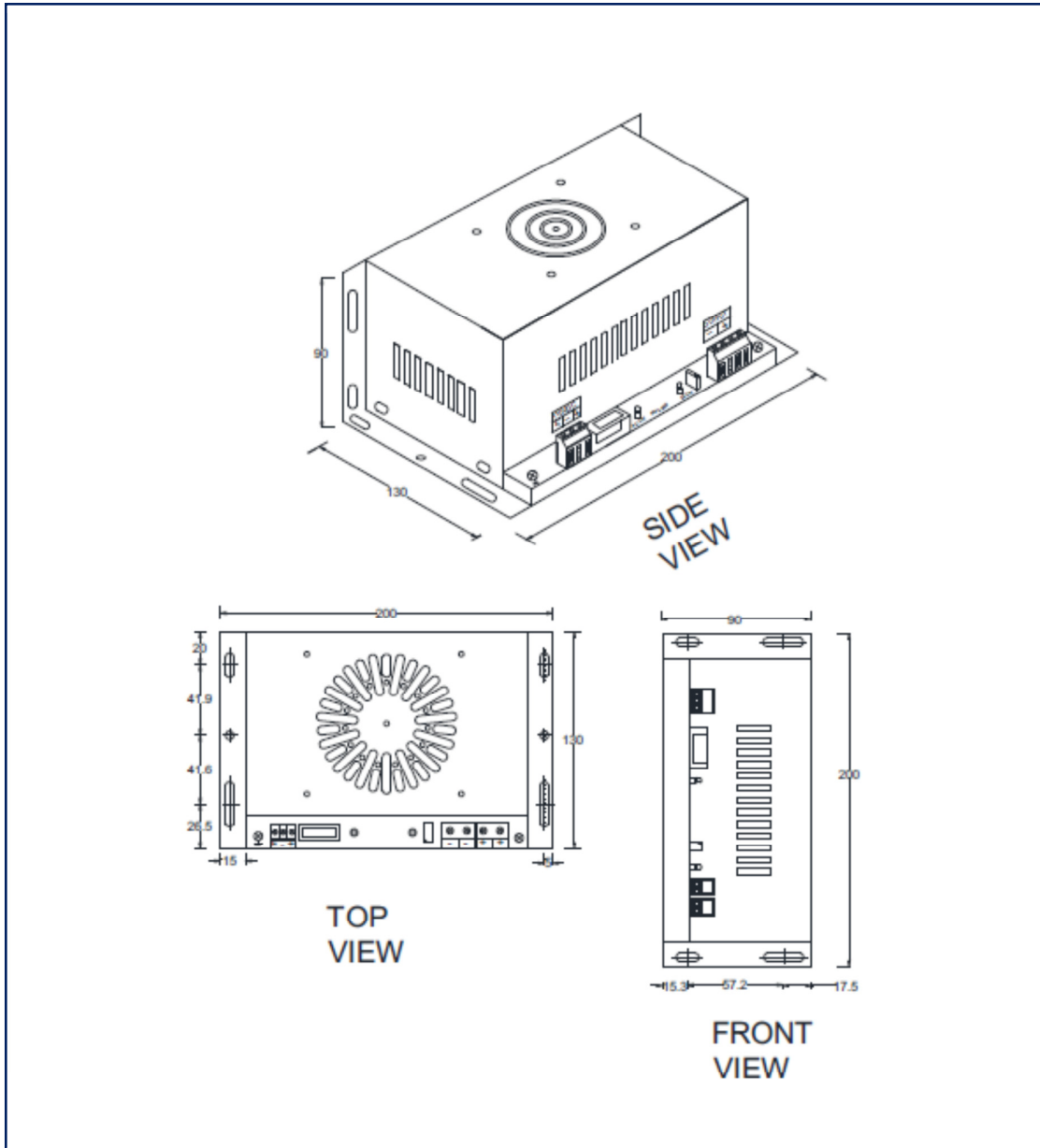

Dimension (mm) – 200*130*90